

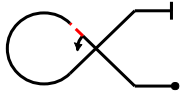



Pilote ID

France Espoirs connu

Vol N°

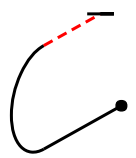
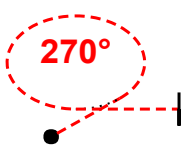
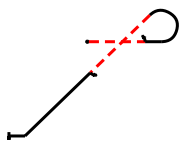
No	Symbol	Cat. No.	K	Total K	Marks	Remarks	Pos	Item	K	Grade
1		7.3.2.1 9.1.2.2	14 6	20 SF 7				Pos.	10	
2		1.1.6.3 9.11.1.5	10 4	14 SF 3				Fig K	118	Total K 128
3		7.2.1.1	6	6 SF 7				<b>Penalties</b>		
4		2.3.1.2	7	7 SF 2				Trop Bas		
5		8.5.8.2 9.1.3.2 9.1.4.2	11 4 4	19 SF 7				Trop Haut		
6		5.2.1.1	17	17 SF 5				Interruptions		
7		7.4.1.1	10	10 SF 7				Insertions		
8		7.2.2.1 9.1.3.2	6 4	10 SF 7				Echauf. non OK		
9		2.2.1.1	4	4 SF 2				Battem. d'Ailes		
10		1.1.1.1 9.2.3.4	2 9	11 SF 7				Disqualifié		
								Autre(noter...)		
								<b>Final Freestyle</b>		
								Duration	Min	Sec
								<b>Judges Details</b>		
								Signature		
								Name		
								Number		

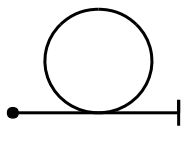
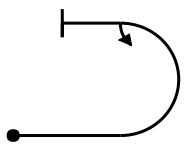
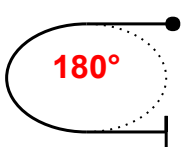
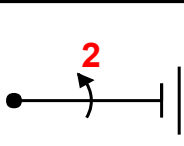
\_\_\_\_\_  
Pilote  
\_\_\_\_\_  
Avion

CONNU 2018		Form B
Pilote ID	France Espoirs connu	Vol N°

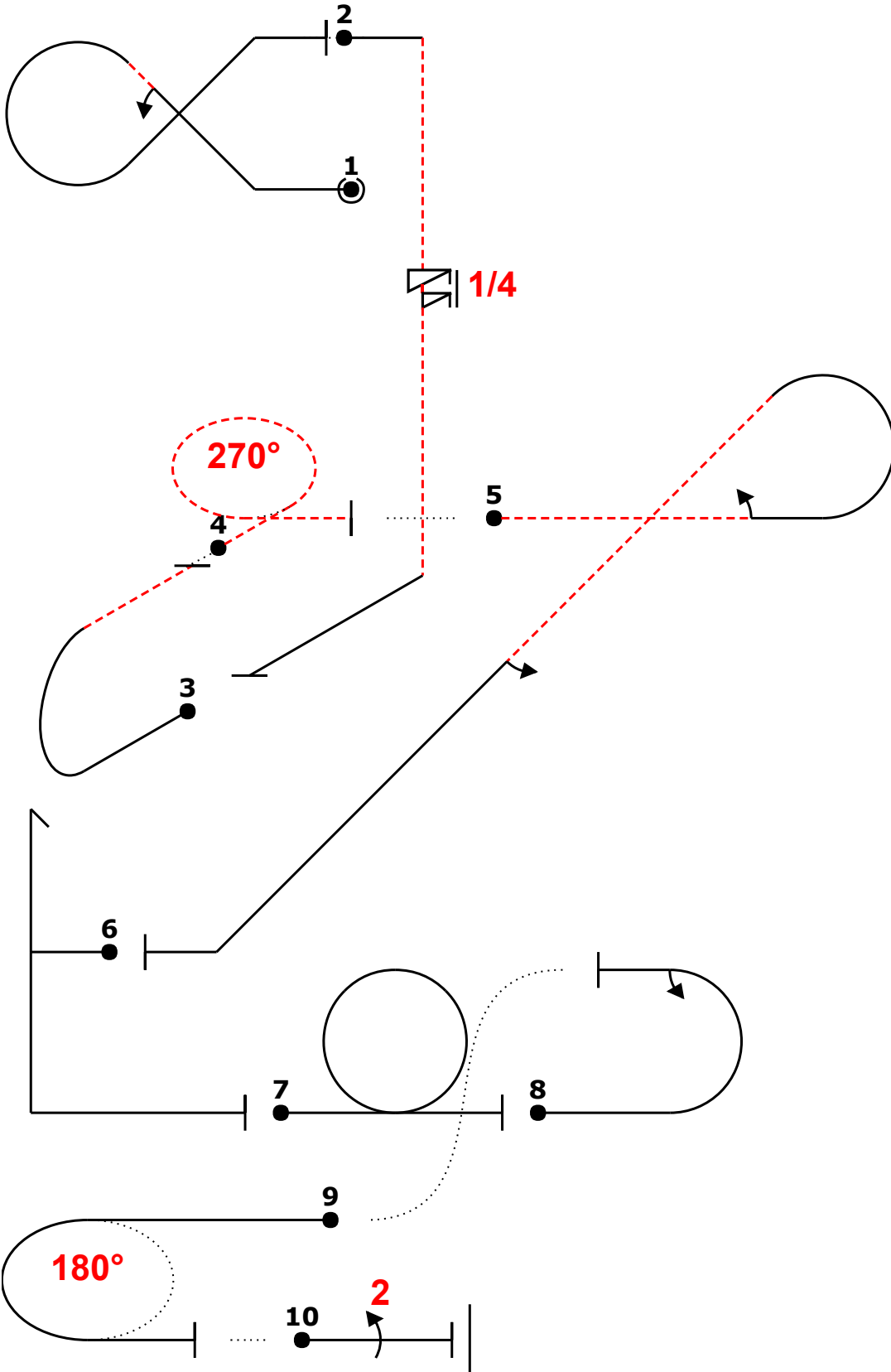

Avion			
Fig 1	7.3.2.1 9.1.2.2	14 6	20
Fig 2	1.1.6.3 9.11.1.5	10 4	14
Fig 3	7.2.1.1	6	6
Fig 4	2.3.1.2	7	7
Fig 5	8.5.8.2 9.1.3.2 9.1.4.2	11 4 4	19
Fig 6	5.2.1.1	17	17
Fig 7	7.4.1.1	10	10
Fig 8	7.2.2.1 9.1.3.2	6 4	10
Fig 9	2.2.1.1	4	4
Fig 10	1.1.1.1 9.2.3.4	2 9	11
<b>Total K = 118</b> (max K = 120)			

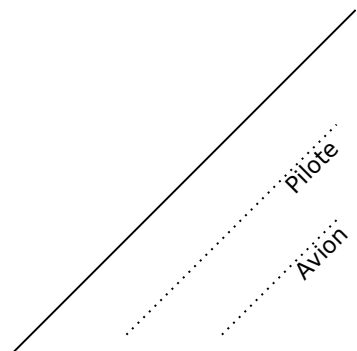

CONNU 2018		Form C
Pilote ID	France Espoirs connu	Vol N°

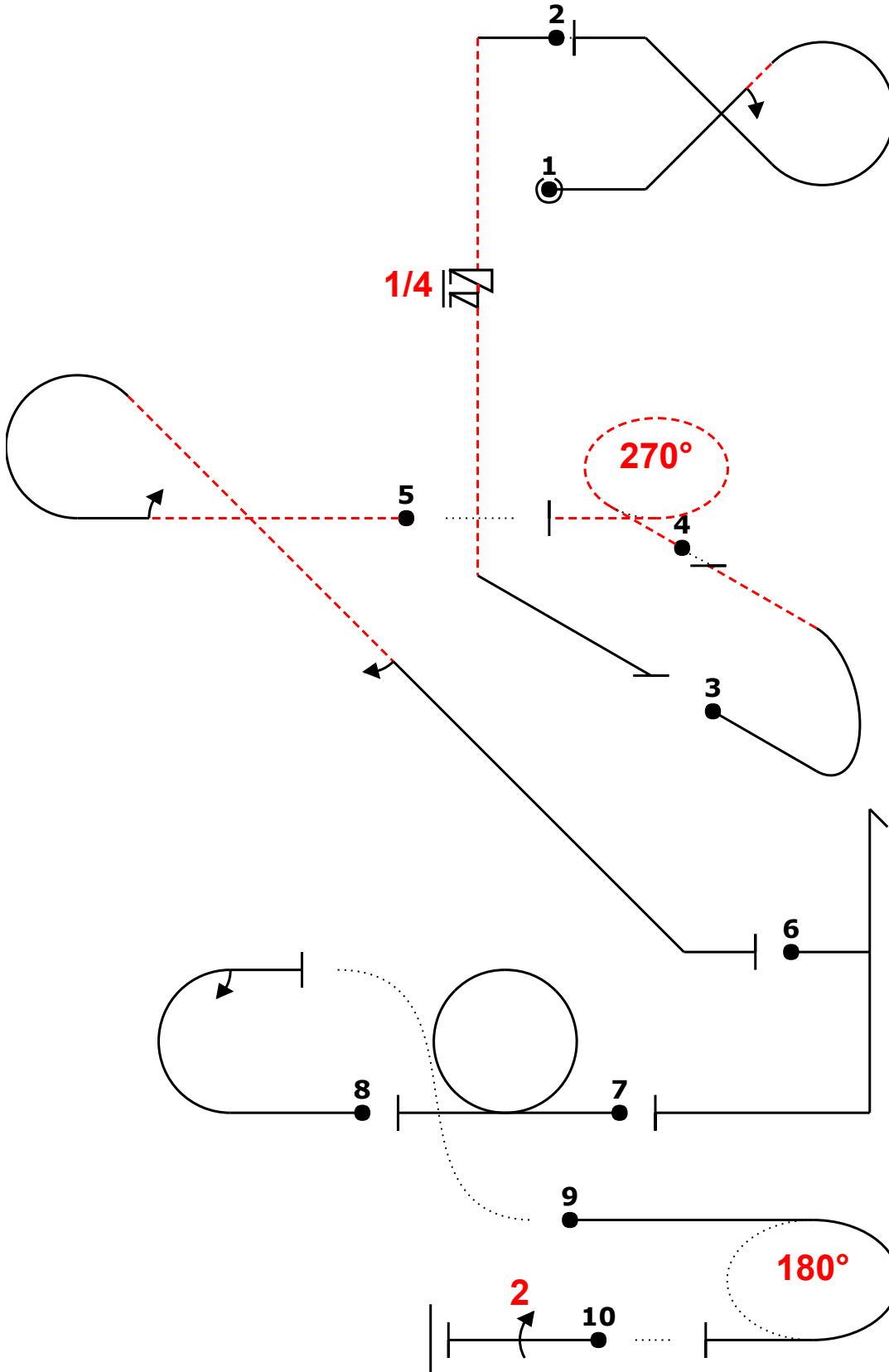

Avion			
Fig 1	7.3.2.1 9.1.2.2	14 6	20
Fig 2	1.1.6.3 9.11.1.5	10 4	14
Fig 3	7.2.1.1	6	6
Fig 4	2.3.1.2	7	7
Fig 5	8.5.8.2 9.1.3.2 9.1.4.2	11 4 4	19
Fig 6	5.2.1.1	17	17
Fig 7	7.4.1.1	10	10
Fig 8	7.2.2.1 9.1.3.2	6 4	10
Fig 9	2.2.1.1	4	4
Fig 10	1.1.1.1 9.2.3.4	2 9	11
<b>Total K = 118</b> (max K = 120)			

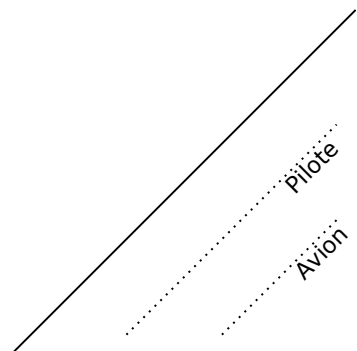



Figure K  
**118**  
K total  
**128**

Nom des Juges		Vol N°
Signature	Numéro	

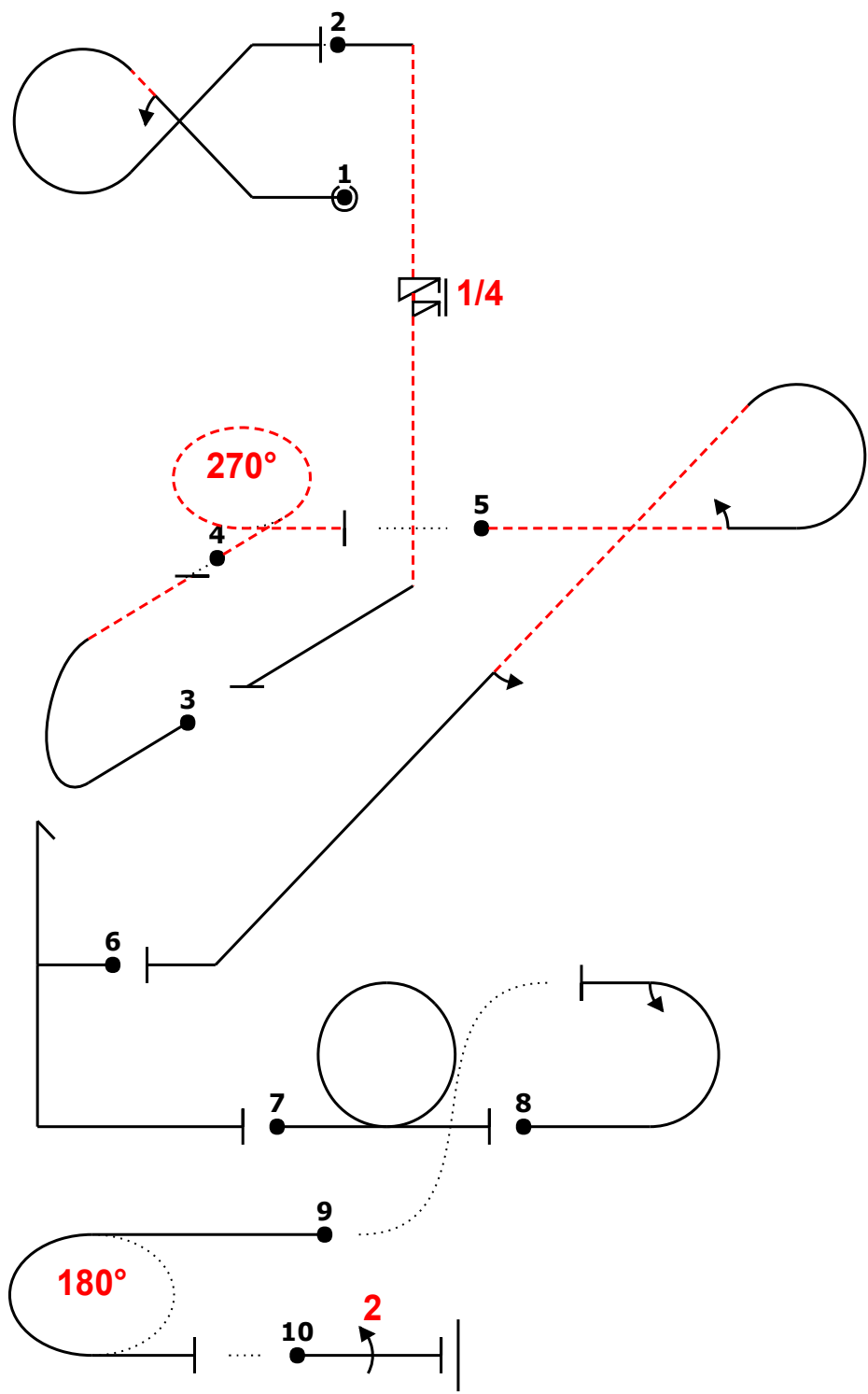

Fig	Pos	Remarks	Grade
1			.
2			.
3			.
4			.
5			.
6			.
7			.
8			.
9			.
10			.

Cadre(Coef)	.
<b>10</b>	.

Trop Bas		Echauf. non OK	
Trop Haut		Battem. d'Ailes	
Interruptions		Disqualifié	
Insertions		Autre(noter...)	

Vérification :11-12-2017 10:56 OpenAero 2018.1.1 2017 france espoirs connu Le programme est correct  
ed (0,0) ~2g (-3,0) iv...5s...'++++ (0,0) .'m.-- (-2,1) -3j-> (4,0) -2.'c.....2.....' h.+++~ o .m2 (-11,14 ) 2% ~+2j~ (2,0) 22

<b>Fig 1</b>	<b>K</b>	<b>Fig 2</b>	<b>K</b>	<b>Fig 3</b>	<b>K</b>	<b>Fig 4</b>	<b>K</b>	<b>Fig 5</b>	<b>K</b>	<b>Fig 6</b>	<b>K</b>	<b>Fig 7</b>	<b>K</b>	<b>Fig 8</b>	<b>K</b>	<b>Fig 9</b>	<b>K</b>	<b>Fig 10</b>	<b>K</b>
7.3.2.1	14	1.1.6.3	10	7.2.1.1	6	2.3.1.2	7	8.5.8.2	11	5.2.1.1	17	7.4.1.1	10	7.2.2.1	6	2.2.1.1	4	1.1.1.1	2
9.1.2.2	6	9.11.1.5	4					9.1.3.2	4					9.1.3.2	4			9.2.3.4	9
<b>SF 7</b>	<b>20</b>	<b>SF 3</b>	<b>14</b>	<b>SF 7</b>	<b>6</b>	<b>SF 2</b>	<b>7</b>	<b>SF 7</b>	<b>19</b>	<b>SF 5</b>	<b>17</b>	<b>SF 7</b>	<b>10</b>	<b>SF 7</b>	<b>10</b>	<b>SF 2</b>	<b>4</b>	<b>SF 7</b>	<b>11</b>

Pilote:

Avion:

Equipe: **FRA**

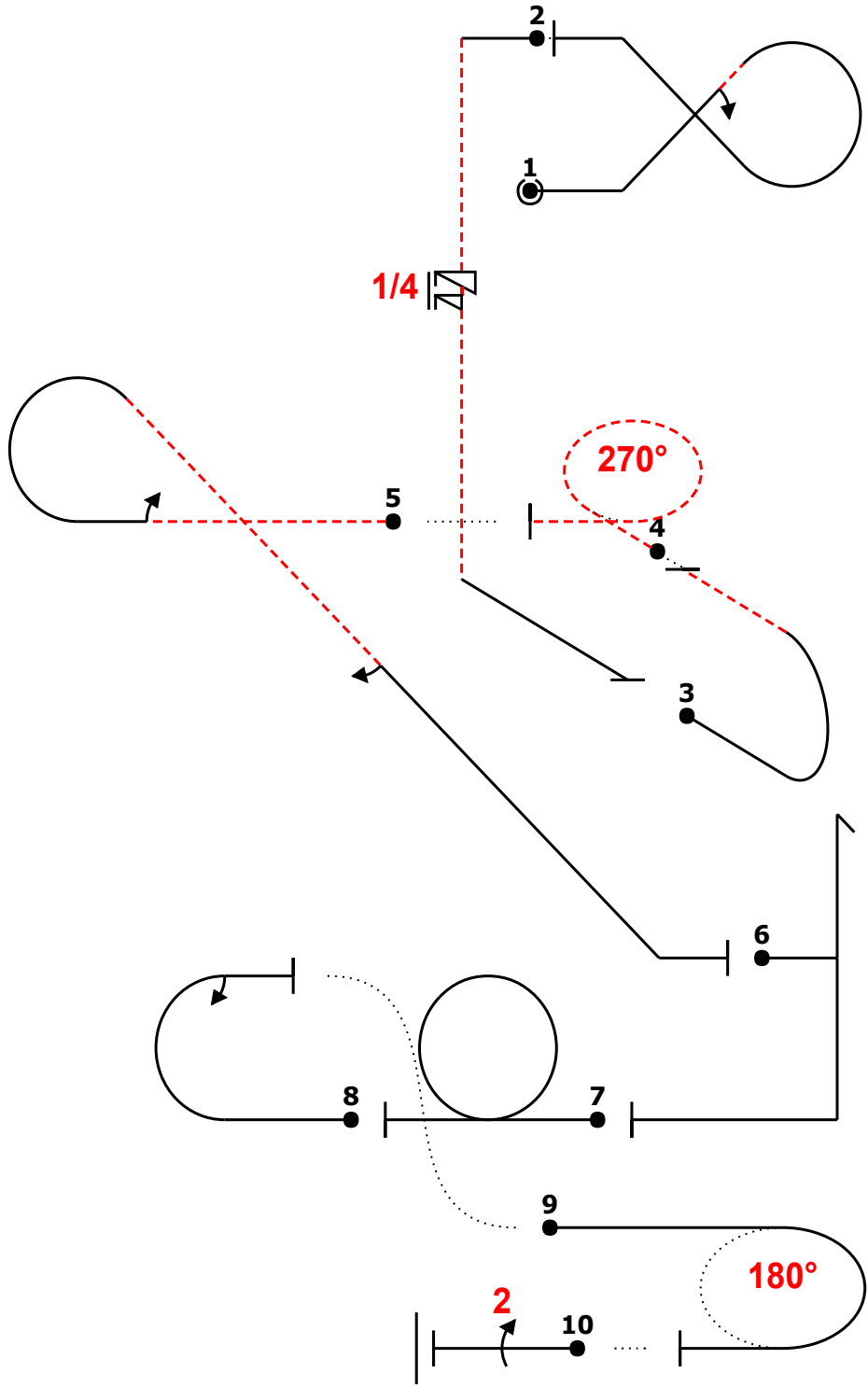

Fig	Pos	Remarks	Grade
1			.
2			.
3			.
4			.
5			.
6			.
7			.
8			.
9			.
10			.

Cadre(Coef)	.
<b>10</b>	.

Trop Bas		Echauf. non OK	
Trop Haut		Battem. d'Ailes	
Interruptions		Disqualifié	
Insertions		Autre(noter...)	

Vérification :11-12-2017 10:56 OpenAero 2018.1.1 2017 france espoirs connu Le programme est correct  
ed (0,0) ~2g (-3,0) iv...5s...''++++ (0,0) .''m.-- (-2,1) -3j-> (4,0) -2.'c.....2....'' h.+++~ o .m2 (-11,14 ) 2% ~++2j~ (2,0) 22

<b>Fig 1</b>	<b>K</b>	<b>Fig 2</b>	<b>K</b>	<b>Fig 3</b>	<b>K</b>	<b>Fig 4</b>	<b>K</b>	<b>Fig 5</b>	<b>K</b>	<b>Fig 6</b>	<b>K</b>	<b>Fig 7</b>	<b>K</b>	<b>Fig 8</b>	<b>K</b>	<b>Fig 9</b>	<b>K</b>	<b>Fig 10</b>	<b>K</b>
7.3.2.1	14	1.1.6.3	10	7.2.1.1	6	2.3.1.2	7	8.5.8.2	11	5.2.1.1	17	7.4.1.1	10	7.2.2.1	6	2.2.1.1	4	1.1.1.1	2
9.1.2.2	6	9.11.1.5	4					9.1.3.2	4					9.1.3.2	4			9.2.3.4	9
<b>SF 7</b>	<b>20</b>	<b>SF 3</b>	<b>14</b>	<b>SF 7</b>	<b>6</b>	<b>SF 2</b>	<b>7</b>	<b>SF 7</b>	<b>19</b>	<b>SF 5</b>	<b>17</b>	<b>SF 7</b>	<b>10</b>	<b>SF 7</b>	<b>10</b>	<b>SF 2</b>	<b>4</b>	<b>SF 7</b>	<b>11</b>

Pilote:

Avion:

Equipe: FRA